

2x

55068, 55069, 55070, 55071,  
55072, 55073, 55074

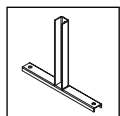

2x

55083

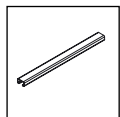

1x

55149

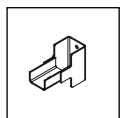

2x

55148

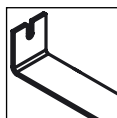

2x

508443



8x

508445



4x

504757



4x

40829

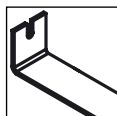

6x

504391



4x

508442

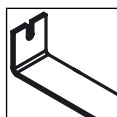

4x

504388

# MONTTECH®

## **MONTAGEANLEITUNG ASSEMBLY INSTRUCTIONS INSTRUCTIONS DE MONTAGE ISTRUZIONI DI MONTAGGIO**

### **KTB/TB 45-250**

**Doppelstütze  
höhenverstellbar  
Double-support  
height adjustable  
Double support  
hauteur réglable  
Doppio supporto  
ad altezza regolabile**

### **508461**



5 0 8 4 6 1

Ausgabe 25.03.2004

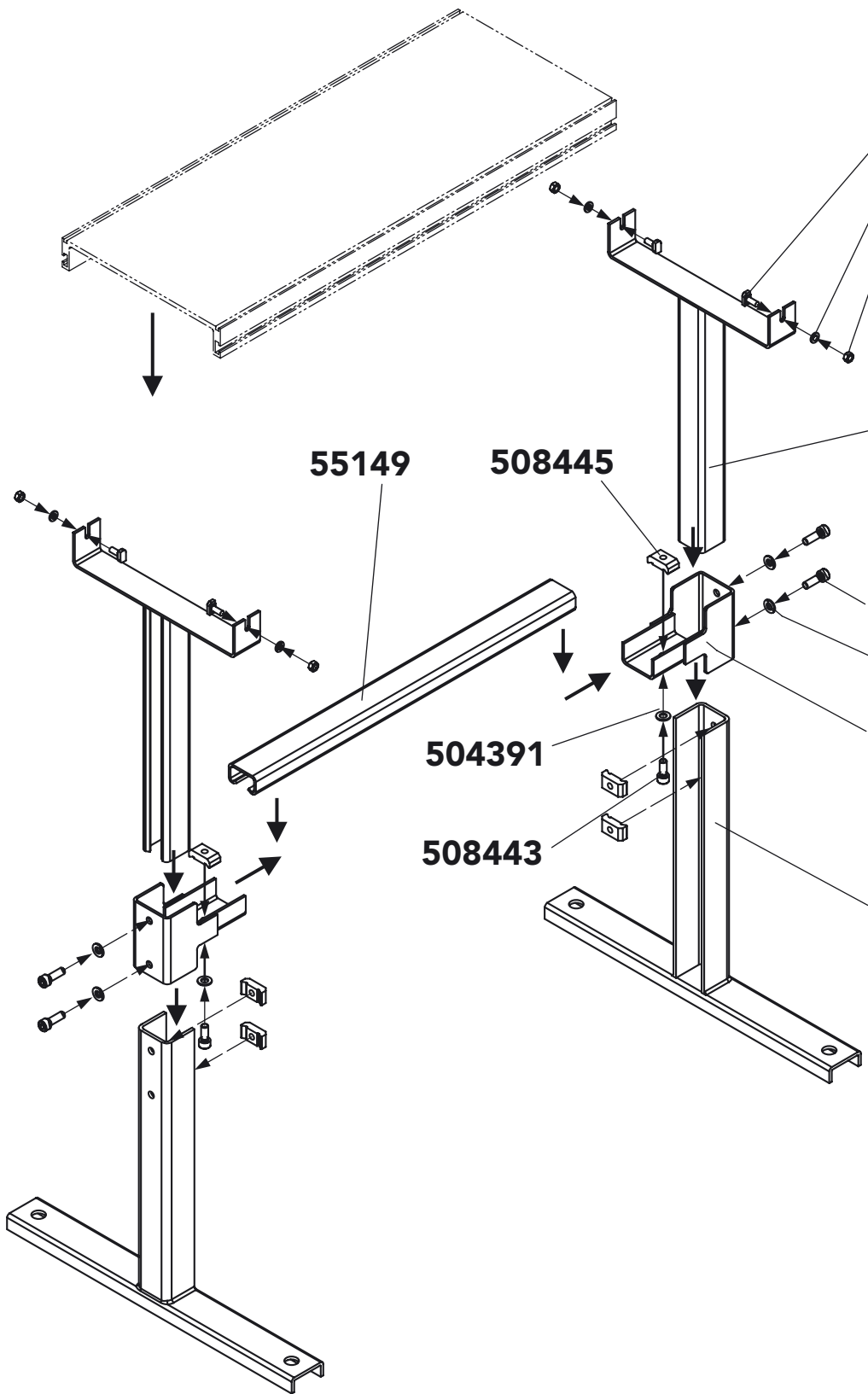

**40829**

**504388**

**504757**

**55068** KTB-45

**55069** KTB/TB-60

**55070** KTB/TB-80

**55071** KTB/TB-105

**55072** KTB/TB-140

**55073** TB-185

**55074** TB-250

**55149**

**508445**

**508442**

**504391**

**504391**

**55148**

**508443**

**55083**