

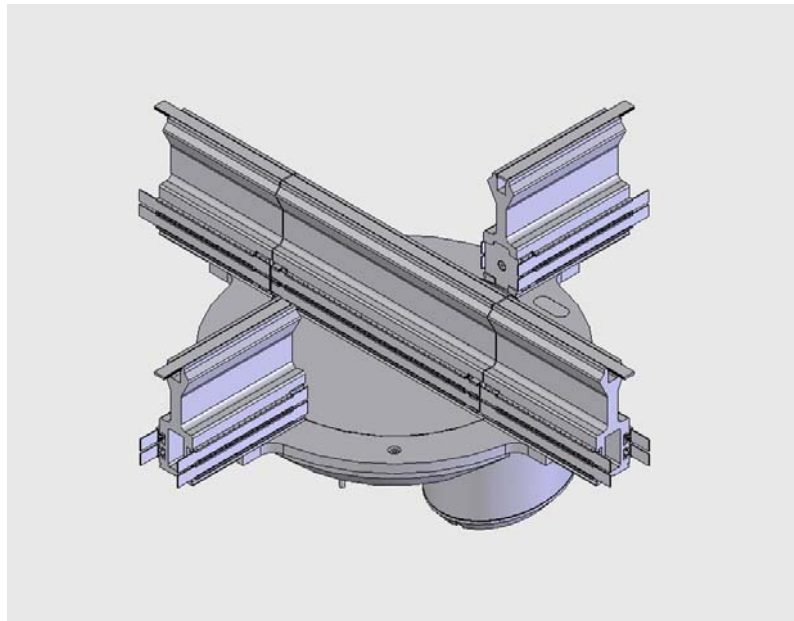

**ERSATZTEILLISTE
SPARE PARTS LIST
LISTE DES PIÈCES DE RECHANGE
ELENCO DEI PEZZI DI RICAMBIO**







TracCrossing

58864

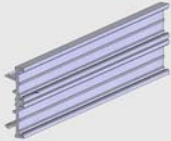

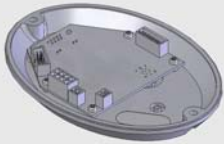
EL-100088

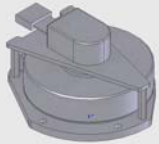
Ausgabe / Edition 10/2009

	D E F I	Führungsprofil Art. Nr. 56750 <i>Guidance profile art. num. 56750</i> Profilé de guidage arc Réf. unité 56750 <i>Profilato di guida Art. No. 56750</i>
	D E F I	Stromschiene Art. Nr. 56748 <i>Conductor rail art. num. 56748</i> Rail d'alimentation Réf. unité 56748 <i>Sbarre colletttrici Art. No. 56748</i>
	D E F I	TracSwitch Steuerung mit Deckel Art. Nr. 58315 <i>TracSwitch control unit with cover art. num. 58315</i> Commande TracSwitch avec couvercle Réf. unité 58315 <i>Controller per TracSwitch con coperchio Art. No. 58315</i>
	D E F I	Verriegelung Art. Nr. 58322 <i>Locking device art. num. 58322</i> Verrouillage arc Réf. unité 58322 <i>Blocco Art. No. 58322</i>
	D E F I	Flachmotor Art. Nr. 57253 <i>Electric motor art. num. 57253</i> Moteur plat Réf. unité 57253 <i>Motore piatto Art. No. 57253</i>
	D E F I	Näherungsschalter Art. Nr. 508842 <i>Proximity switch unit art. num. 508842</i> Détecteur de proximité Réf. unité 508842 <i>Interruttore di prossimità Art. No. 508842</i>